



Fliesenrahmen

Leitungen und Rohre in gefliesten Wänden?



Sicher verschlossen und bei Bedarf
jederzeit leicht zugänglich mit
Fliesenrahmen von RUG SEMIN



Kunststoff-Fliesenrahmen mit Magneten

Bestell-Nr.	Fliesengröße		Rahmenmaß		Fliesenanzahl	VPE / VE
	A	B	D	E		
52-427	100	200	209	206	2	5 / 1
52-434	150	150	156	156	1	5 / 1
52-422	150	150	156	309	2	5 / 1
52-423	150	150	309	309	4	5 / 1
52-436	150	200	156	206	1	5 / 1
52-437	150	200	309	206	2	5 / 1
52-438	150	200	309	409	4	5 / 1
52-431	150	300	306	156	1	5 / 1
52-432	150	300	306	309	2	5 / 1
52-435	200	200	206	206	1	5 / 1
52-429	200	200	206	409	2	5 / 1
52-430	200	200	409	409	4	5 / 1
52-442	200	250	206	256	1	5 / 1
52-443	200	250	409	256	2	5 / 1
52-439	200	300	206	306	1	5 / 1
52-441	200	300	409	306	2	5 / 1
52-440	250	250	256	256	1	5 / 1
52-445	250	330	256	336	1	5 / 1

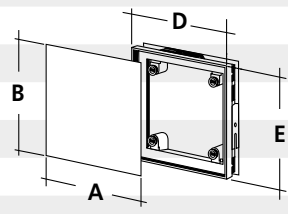

Alle Maßangaben sind in mm

Trägerplatte aus feuerverzinktem Stahlblech
Rahmen Kunststoff weiß, Magnete sind höhenverstellbar
Der stabile Kunststoffrahmen dient als Fuge

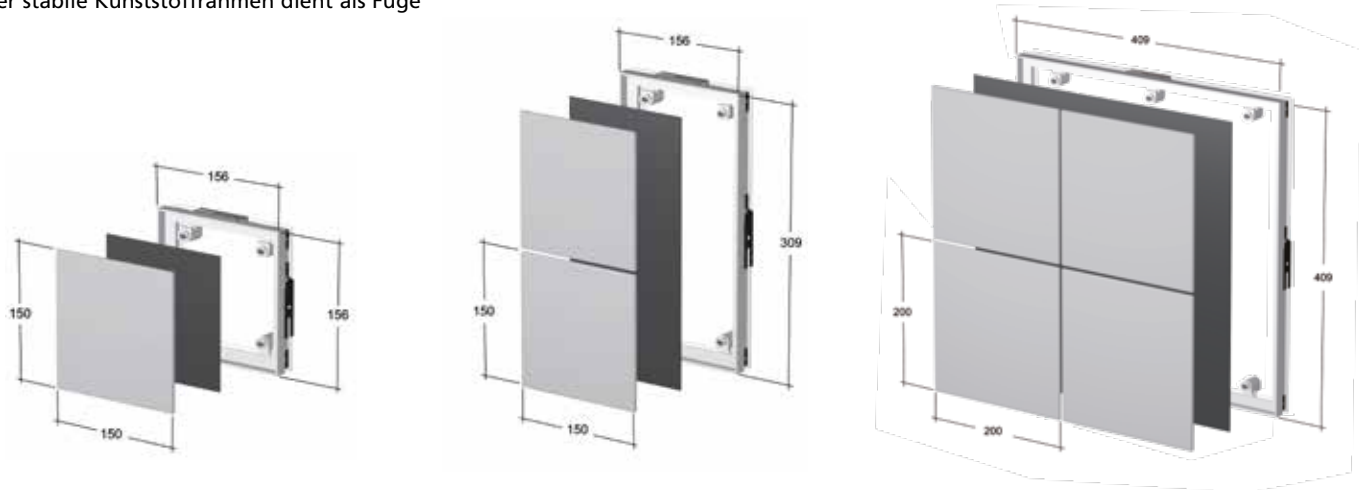

Fliesenrahmen Edelstahl

Bestell-Nr.	Abmessungen in mm			Edelstahl-Winkel-Profil 8 mm	VPE / VE
	A	B	C		
51-379	150	150	8		10 / 1
51-361	150	200	8		10 / 1
51-380	150	300	8		10 / 1
51-388	200	200	8		10 / 1
51-359	200	250	8		10 / 1
51-389	200	300	8		10 / 1
51-381	300	300	8		10 / 1

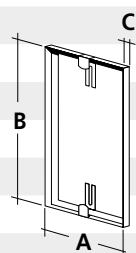

Alle Maßangaben sind in mm

Niro-Abdeckrahmen

Bestell-Nr.	Fliesengröße		Rahmenmaß		VPE / VE
	A	B	D	E	
51-405	170	170	150	150	1 / 1
51-410	220	220	200	200	1 / 1
51-415	270	270	250	250	1 / 1
51-420	320	320	300	300	1 / 1

Alle Maßangaben sind in mm



Edelstahl
mit Rahmen und Schrauben

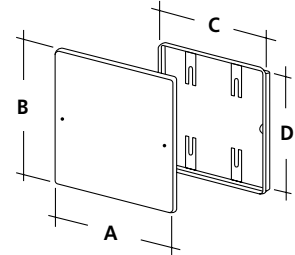

Fliesenmagnete

Bestell-Nr.	Abmessungen in mm			Beutelinhalt	VPE / VE
	A	B	C		
54-020	49	34	14	4	20 / 1

Alle Maßangaben sind in mm



4 Fliesenmagnete, 4 Gegenplättchen,
Gegenplättchen feuerverzinktes Stahlblech

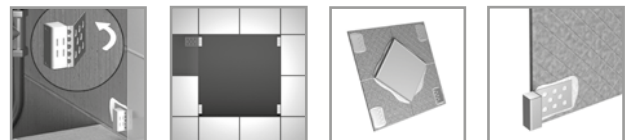
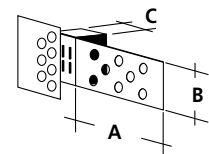

Saughalter



Zum leichten Öffnen von Fliesenrahmen o.ä.
Material: Kunststoff / Gummi

1 / 1

52-400

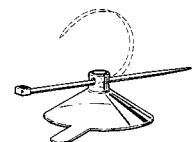

Einbau Kunststoff-Fliesenrahmen

