



# Cadres pour carrelages

Câbles et tuyaux dans des murs carrelés ?



Fermeture sûre et, accès facile à tout moment avec le cadre à carreler de RUG SEMIN



### Cadre pour carrelage aimanté en plastique

Référence	Dimensions des carreaux		Dimensions du cadre		Nombre de carreaux	UC / UV
	A	B	D	E		
52-427	100	200	209	206	2	5 / 1
52-434	150	150	156	156	1	5 / 1
52-422	150	150	156	309	2	5 / 1
52-423	150	150	309	309	4	5 / 1
52-436	150	200	156	206	1	5 / 1
52-437	150	200	309	206	2	5 / 1
52-438	150	200	309	409	4	5 / 1
52-431	150	300	306	156	1	5 / 1
52-432	150	300	306	309	2	5 / 1
52-435	200	200	206	206	1	5 / 1
52-429	200	200	206	409	2	5 / 1
52-430	200	200	409	409	4	5 / 1
52-442	200	250	206	256	1	5 / 1
52-443	200	250	409	256	2	5 / 1
52-439	200	300	206	306	1	5 / 1
52-441	200	300	409	306	2	5 / 1
52-440	250	250	256	256	1	5 / 1
52-445	250	330	256	336	1	5 / 1

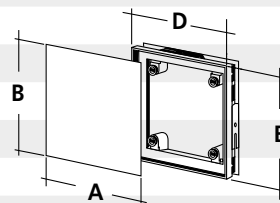

Toutes les dimensions indiquées sont en mm

Plaque support en tôle d'acier galvanisée  
Cadre plastique blanc, les aimants sont réglables en hauteur  
Le cadre plastique stable sert de joint

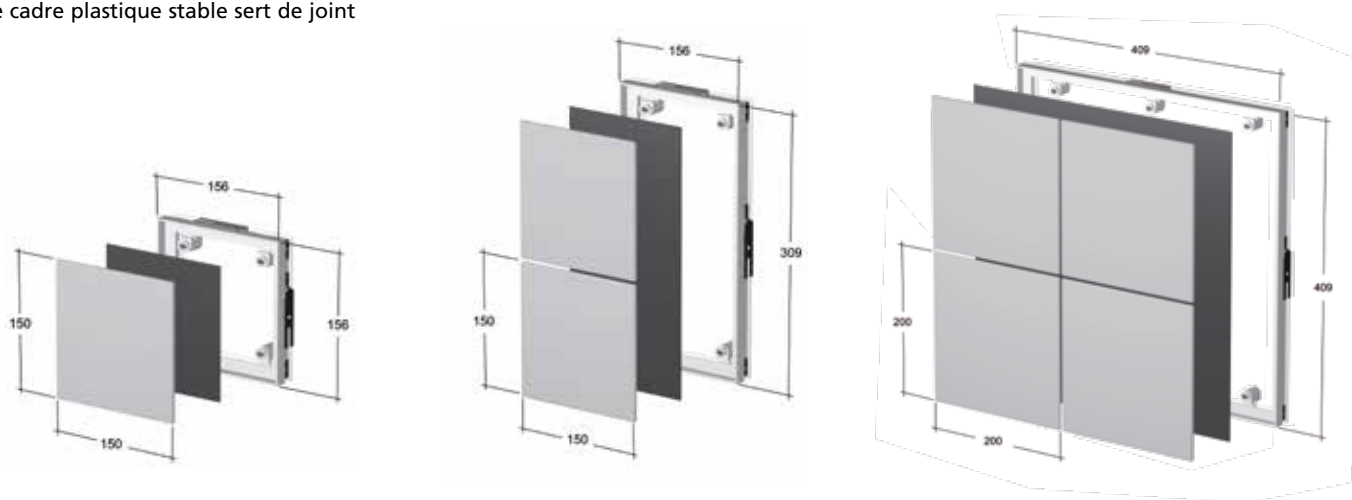

### Cadre pour carrelage en acier inoxydable

Référence	Dimensions en mm			Profilé d'angle en acier inoxydable 8 mm	UC / UV
	A	B	C		
51-379	150	150	8		10 / 1
51-361	150	200	8		10 / 1
51-380	150	300	8		10 / 1
51-388	200	200	8		10 / 1
51-359	200	250	8		10 / 1
51-389	200	300	8		10 / 1
51-381	300	300	8		10 / 1

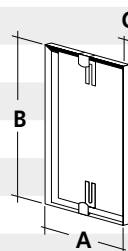

Toutes les dimensions indiquées sont en mm

### Cadre de recouvrement en acier inoxydable

Référence	Dimensions des carreaux		Dimensions du cadre		UC / UV
	A	B	D	E	
51-405	170	170	150	150	1 / 1
51-410	220	220	200	200	1 / 1
51-415	270	270	250	250	1 / 1
51-420	320	320	300	300	1 / 1

Toutes les dimensions indiquées sont en mm



Acier inoxydable  
avec cadre et vis

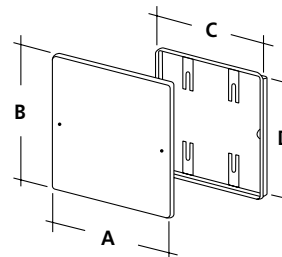

### Aimants de fixation du carrelage

Référence	Dimensions en mm			Contenu du sachet	UC / UV
	A	B	C		
54-020	49	34	14	4	20 / 1

Toutes les dimensions indiquées sont en mm



4 aimants de carreaux, 4 contre-plaquettes,  
contre-plaquettes en tôle en acier galvanisé

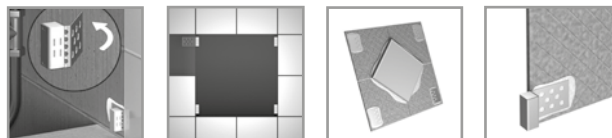
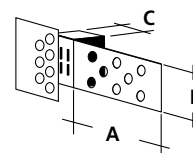

### Support à ventouse



pour l'ouverture facile des cadres à carreler  
entre autres  
Matériau : Matière plastique / caoutchouc

1 / 1

52-400

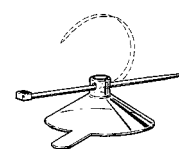

# Montage cadre à carreler en matière plastique

